

## Technische Daten Aluminiumprofile Baureihe BSB 45

### Strangpressprofile nach DIN EN 12020-1

Legierung	AL Mg Si 0,5 F25
Werkstoff	Nr. 3.3206.72 (warmausgehärtet)
<b>Mechanische Daten (Werte in Pressrichtung)</b>	
Zugfestigkeit Rm	min. 240 N/mm <sup>2</sup>
Dehngrenze Rp 0,2	min. 190 N/mm <sup>2</sup>
Bruchdehnung A <sub>5</sub>	min. 10%
E-Modul	ca. 70.000 N/mm <sup>2</sup>
Brinellhärte	ca. 75 HB 2,5/187,5
Längenausdehnungs-Koeffizient	23,8x10 <sup>-6</sup> /K
Oberfläche nach DIN 17611	E6/EV1-mattgebeizt und naturfarben eloxiert
Schichtdicke	ca. 10µm
Schichthärte	250-350 HV
Sonderfarben auf Anfrage	
Lieferlänge 6000mm (oder spezielle Angaben im Katalog)	

### Profiltoleranzen

Die Maßangaben sind abhängig von der Herstellgenauigkeit der Werkzeuge, vom Werkzeugverschleiß und den Fertigungsschwankungen. Innerhalb einer Fertigungscharge eines Profils liegen die Abweichungen untereinander im 1/100-Bereich

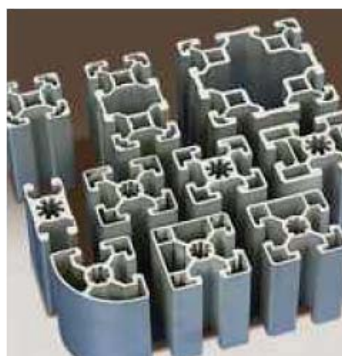

### Profiltoleranzen in mm

Meßbereich von - bis	Toleranz ±
0 – 10	± 0,15
10 – 15	± 0,20
15 – 30	± 0,25
30 – 45	± 0,30
45 – 60	± 0,40
60 - 90	± 0,45
90 – 120	± 0,60
120 – 150	± 0,80
150 – 180	± 1,00
180 - 240	± 1,20

**Profil 20X20**



Artikel Nr.:	022206
Ix	0,70 cm <sup>4</sup>
Iy	0,70 cm <sup>4</sup>
Wx	0,70 cm <sup>3</sup>
Wy	0,70 cm <sup>3</sup>
Profilfläche	1,60 cm <sup>2</sup>
Masse	0,44 kg/m

**Nut 6**

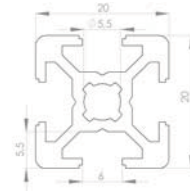

**Profil 20X40**



Artikel Nr.:	14423
Ix	4,60 cm <sup>4</sup>
Iy	1,20 cm <sup>4</sup>
Wx	2,50 cm <sup>3</sup>
Wy	1,40 cm <sup>3</sup>
Profilfläche	2,90 cm <sup>2</sup>
Masse	0,80 kg/m

**Nut 6**

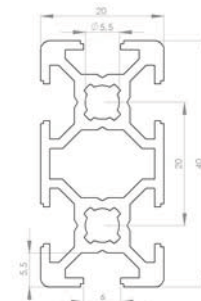

**Profil 30X30**

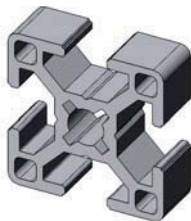

Artikel Nr.:	019617
Ix	2,70 cm <sup>4</sup>
Iy	2,70 cm <sup>4</sup>
Wx	1,80 cm <sup>3</sup>
Wy	1,80 cm <sup>3</sup>
Profilfläche	2,90 cm <sup>2</sup>
Masse	0,80 kg/m

**Nut 8**

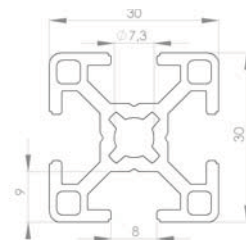

**Profil 30X60**

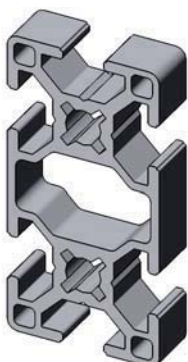

Artikel Nr.:	021842
Ix	19,70 cm <sup>4</sup>
Iy	5,10 cm <sup>4</sup>
Wx	7,00 cm <sup>3</sup>
Wy	3,90 cm <sup>3</sup>
Profilfläche	5,60 cm <sup>2</sup>
Masse	1,50 kg/m

**Nut 8**

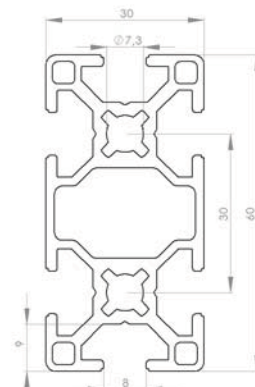

**Profil 30X30 1N**

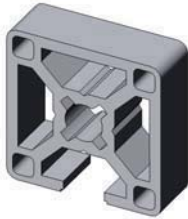

Artikel Nr.:	13755
Ix	2,70 cm <sup>4</sup>
Iy	2,70 cm <sup>4</sup>
Wx	1,80 cm <sup>3</sup>
Wy	1,80 cm <sup>3</sup>
Profilfläche	3,10 cm <sup>2</sup>
Masse	0,80 kg/m

**Nut 8**

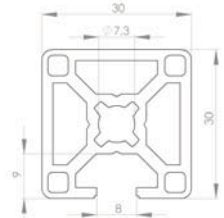

**Profil 30X30 2N90**

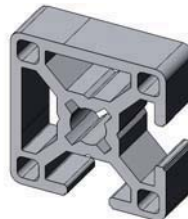

Artikel Nr.:	11061
Ix	2,70 cm <sup>4</sup>
Iy	2,70 cm <sup>4</sup>
Wx	1,80 cm <sup>3</sup>
Wy	1,80 cm <sup>3</sup>
Profilfläche	3,10 cm <sup>2</sup>
Masse	0,80 kg/m

**Nut 8**

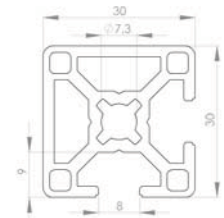

**Profil 30X30 2N180**

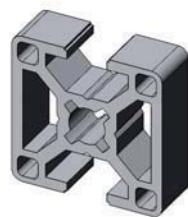

Artikel Nr.:	13481
Ix	2,70 cm <sup>4</sup>
Iy	2,70 cm <sup>4</sup>
Wx	1,80 cm <sup>3</sup>
Wy	1,80 cm <sup>3</sup>
Profilfläche	3,10 cm <sup>2</sup>
Masse	0,80 kg/m

**Nut 8**

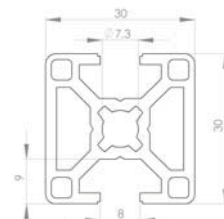

**Profil 30X30 3N**



Artikel Nr.:	10994
Ix	2,70 cm <sup>4</sup>
Iy	2,70 cm <sup>4</sup>
Wx	1,80 cm <sup>3</sup>
Wy	1,80 cm <sup>3</sup>
Profilfläche	3,10 cm <sup>2</sup>
Masse	0,80 kg/m

**Nut 8**

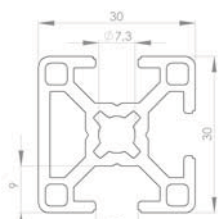

### Profil 30x30R



Artikel Nr.:	12378
I <sub>x</sub>	2,30 cm <sup>4</sup>
I <sub>y</sub>	2,30 cm <sup>4</sup>
W <sub>x</sub>	1,40 cm <sup>3</sup>
W <sub>y</sub>	1,40 cm <sup>3</sup>
Profilfläche	2,90 cm <sup>2</sup>
Masse	0,80 kg/m

### Nut 8

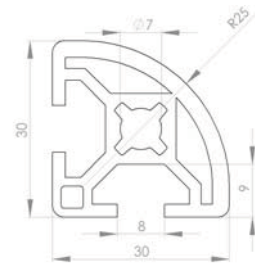

### Profil 40x40L

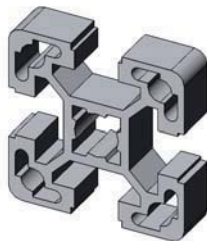

Artikel Nr.:	022667
I <sub>x</sub>	9,00 cm <sup>4</sup>
I <sub>y</sub>	9,00 cm <sup>4</sup>
W <sub>x</sub>	4,50 cm <sup>3</sup>
W <sub>y</sub>	4,50 cm <sup>3</sup>
Profilfläche	5,60 cm <sup>2</sup>
Masse	1,50 kg/m

### Nut 10

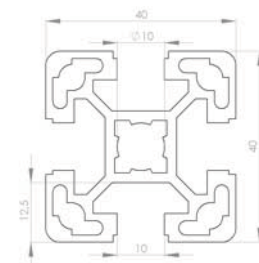

### Profil 40x80L

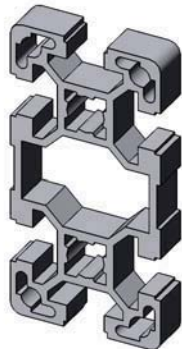

Artikel Nr.:	022668
I <sub>x</sub>	63,40 cm <sup>4</sup>
I <sub>y</sub>	17,30 cm <sup>4</sup>
W <sub>x</sub>	15,90 cm <sup>3</sup>
W <sub>y</sub>	8,70 cm <sup>3</sup>
Profilfläche	9,90 cm <sup>2</sup>
Masse	2,70 kg/m

### Nut 10

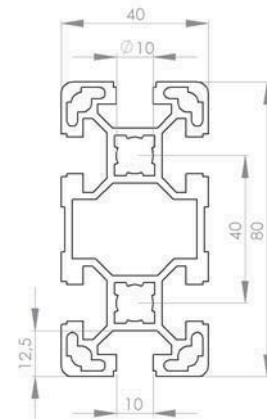

### Profil 40X120L

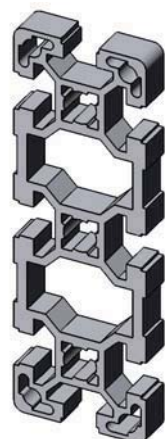

Artikel Nr.:	14457
I <sub>x</sub>	203,20 cm <sup>4</sup>
I <sub>y</sub>	27,80 cm <sup>4</sup>
W <sub>x</sub>	33,90 cm <sup>3</sup>
W <sub>y</sub>	13,90 cm <sup>3</sup>
Profilfläche	15,50 cm <sup>2</sup>
Masse	4,20 kg/m

### Nut 10

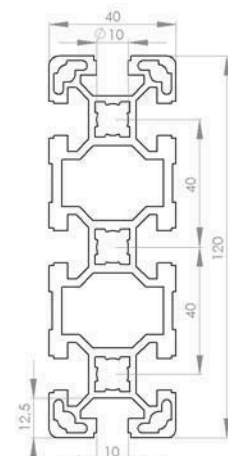

**Profil 40X40 3N**

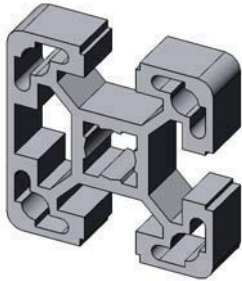

Artikel Nr.:	13855
Ix	9,00 cm <sup>4</sup>
Iy	9,00 cm <sup>4</sup>
Wx	4,50 cm <sup>3</sup>
Wy	4,50 cm <sup>3</sup>
Profilfläche	5,60 cm <sup>2</sup>
Masse	1,50 kg/m

**Nut 10**

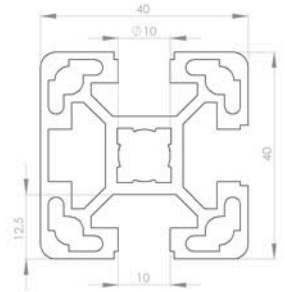

**Profil 40X40L 2N90**

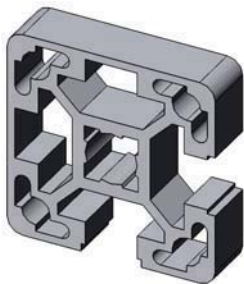

Artikel Nr.:	13766
Ix	9,00 cm <sup>4</sup>
Iy	9,00 cm <sup>4</sup>
Wx	4,50 cm <sup>3</sup>
Wy	4,50 cm <sup>3</sup>
Profilfläche	5,60 cm <sup>2</sup>
Masse	1,50 kg/m

**Nut 10**

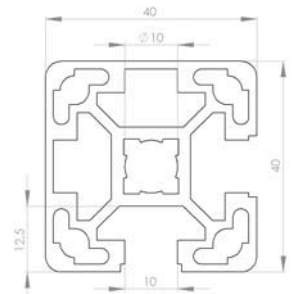

**Profil 40X40L 2N180**

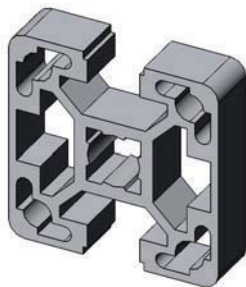

Artikel Nr.:	13854
Ix	9,00 cm <sup>4</sup>
Iy	9,00 cm <sup>4</sup>
Wx	4,50 cm <sup>3</sup>
Wy	4,50 cm <sup>3</sup>
Profilfläche	5,6 cm <sup>2</sup>
Masse	1,50 kg/m

**Nut 10**

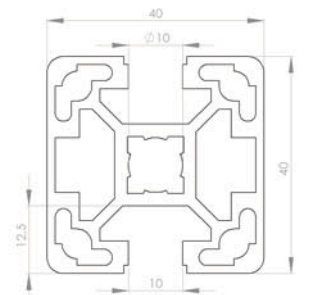

**Profil 19x30**

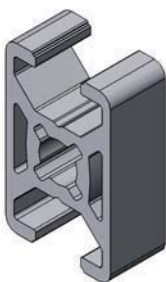

Artikel Nr.:	14577
Ix	cm <sup>4</sup>
Iy	cm <sup>4</sup>
Wx	cm <sup>3</sup>
Wy	cm <sup>3</sup>
Profilfläche	cm <sup>2</sup>
Masse	kg/m

**Nut 8**

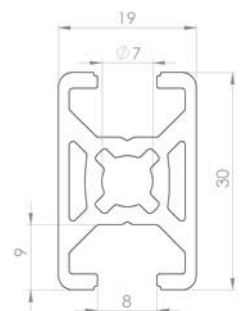

**Profil 30X45**

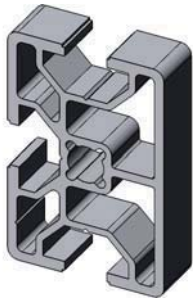

Artikel Nr.:	13470
Ix	8,10 cm <sup>4</sup>
Iy	3,90 cm <sup>4</sup>
Wx	3,60 cm <sup>3</sup>
Wy	2,50 cm <sup>3</sup>
Profilfläche	3,90 cm <sup>2</sup>
Masse	1,10 kg/m

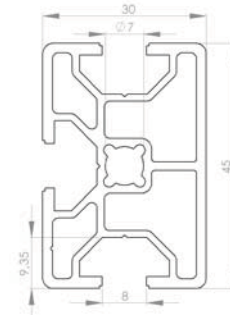

**Nut 8**

**Profil 45X45L**



Artikel Nr.:	019612
Ix	11,00 cm <sup>4</sup>
Iy	11,00 cm <sup>4</sup>
Wx	4,80 cm <sup>3</sup>
Wy	4,80 cm <sup>3</sup>
Profilfläche	5,70 cm <sup>2</sup>
Masse	1,50 kg/m

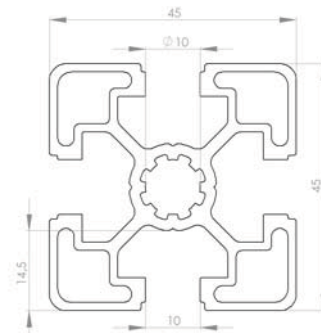

**Nut 10**

**Profil 45X45**

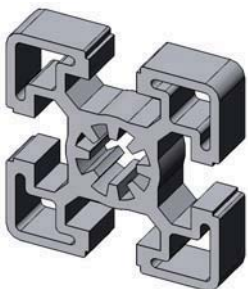

Artikel Nr.:	019611
Ix	14,00 cm <sup>4</sup>
Iy	14,00 cm <sup>4</sup>
Wx	6,10 cm <sup>3</sup>
Wy	6,10 cm <sup>3</sup>
Profilfläche	7,50 cm <sup>2</sup>
Masse	2,00 kg/m

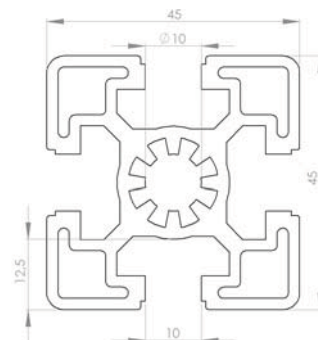

**Nut 10**

**Profil 45X45R**

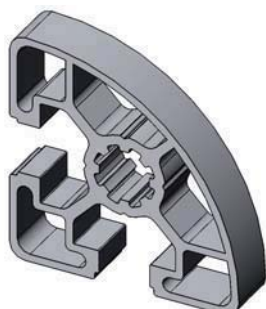

Artikel Nr.:	10861
Ix	8,50 cm <sup>4</sup>
Iy	8,50 cm <sup>4</sup>
Wx	5,00 cm <sup>3</sup>
Wy	5,00 cm <sup>3</sup>
Profilfläche	4,90 cm <sup>2</sup>
Masse	1,30 kg/m

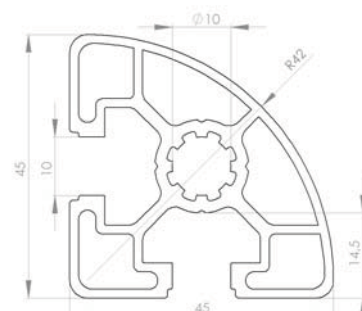

**Nut 10**

**Profil 45X45L 3N**



Artikel Nr.:	022020
Ix	11,00 cm <sup>4</sup>
Iy	11,00 cm <sup>4</sup>
Wx	4,80 cm <sup>3</sup>
Wy	4,80 cm <sup>3</sup>
Profilfläche	5,70 cm <sup>2</sup>
Masse	1,50 kg/m

**Nut 10**

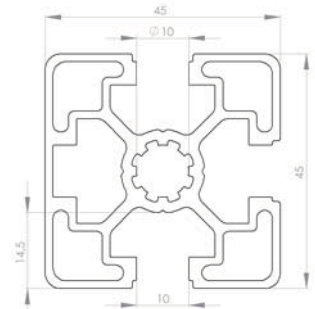

**Profil 45X45L 2N90**

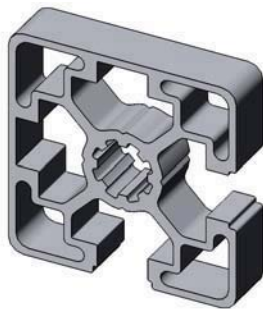

Artikel Nr.:	11772
Ix	11,00 cm <sup>4</sup>
Iy	11,00 cm <sup>4</sup>
Wx	4,80 cm <sup>3</sup>
Wy	4,80 cm <sup>3</sup>
Profilfläche	5,70 cm <sup>2</sup>
Masse	1,50 kg/m

**Nut 10**

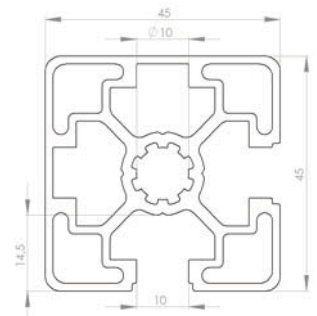

**Profil 45X45L 2N180**

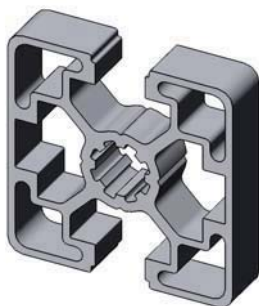

Artikel Nr.:	13448
Ix	11,00 cm <sup>4</sup>
Iy	11,00 cm <sup>4</sup>
Wx	4,80 cm <sup>3</sup>
Wy	4,80 cm <sup>3</sup>
Profilfläche	5,70 cm <sup>2</sup>
Masse	1,50 kg/m

**Nut 10**

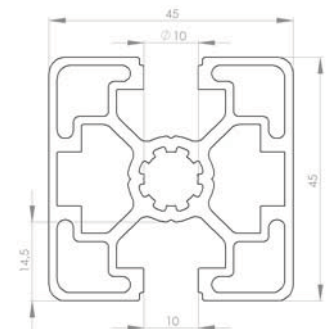

**Profil 45X45L 1N**

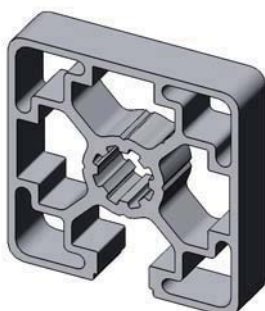

Artikel Nr.:	13754
Ix	11,00 cm <sup>4</sup>
Iy	11,00 cm <sup>4</sup>
Wx	4,80 cm <sup>3</sup>
Wy	4,80 cm <sup>3</sup>
Profilfläche	5,70 cm <sup>2</sup>
Masse	1,50 kg/m

**Nut 10**

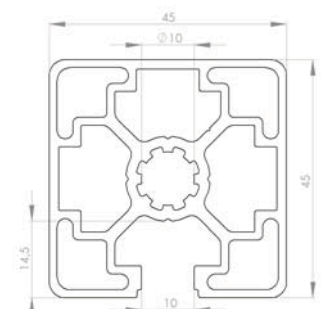

**Profil 45X90L**

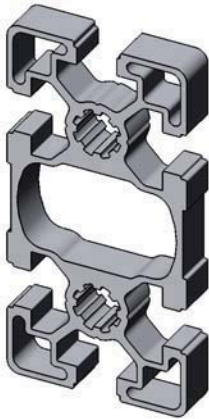

Artikel Nr.:	020998
Ix	81,90 cm <sup>4</sup>
Iy	23,60 cm <sup>4</sup>
Wx	18,20 cm <sup>3</sup>
Wy	10,50 cm <sup>3</sup>
Profilfläche	11,20 cm <sup>2</sup>
Masse	3,10 kg/m

**Nut 10**

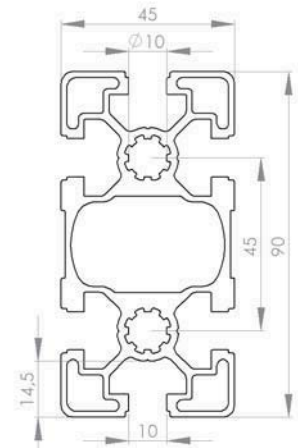

**Profil 45X90**



Artikel Nr.:	021203
Ix	125,00 cm <sup>4</sup>
Iy	32,80 cm <sup>4</sup>
Wx	27,70 cm <sup>3</sup>
Wy	14,60 cm <sup>3</sup>
Profilfläche	15,60 cm <sup>2</sup>
Masse	4,20 kg/m

**Nut 10**

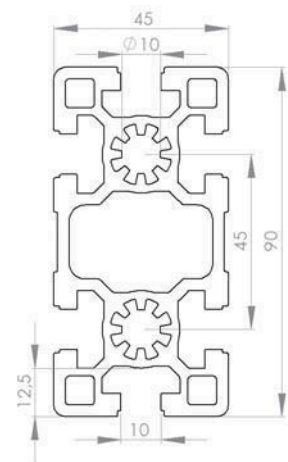

**Profil 50X50L**

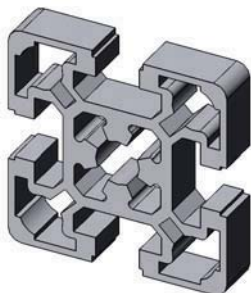

Artikel Nr.:	13472
Ix	21,20 cm <sup>4</sup>
Iy	21,20 cm <sup>4</sup>
Wx	8,50 cm <sup>3</sup>
Wy	8,50 cm <sup>3</sup>
Profilfläche	9,30 cm <sup>2</sup>
Masse	2,50 kg/m

**Nut 10**

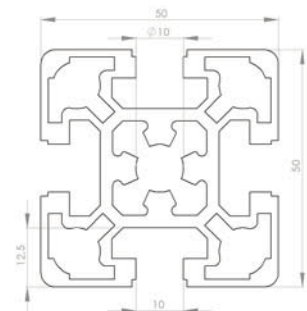



**Profil 45X60**



Artikel Nr.:	019610
Ix	37,20 cm <sup>4</sup>
Iy	22,70 cm <sup>4</sup>
Wx	12,40 cm <sup>3</sup>
Wy	10,10 cm <sup>3</sup>
Profilfläche	11,00 cm <sup>2</sup>
Masse	3,00 kg/m

**Nut 10**

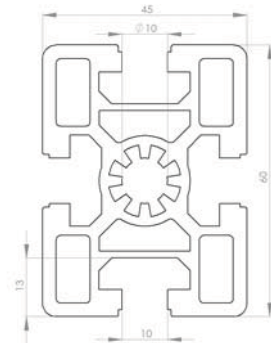

**Profil 60X60L**



Artikel Nr.:	019614
Ix	32,40 cm <sup>4</sup>
Iy	32,40 cm <sup>4</sup>
Wx	10,80 cm <sup>3</sup>
Wy	10,80 cm <sup>3</sup>
Profilfläche	9,60 cm <sup>2</sup>
Masse	2,60 kg/m

**Nut 10**

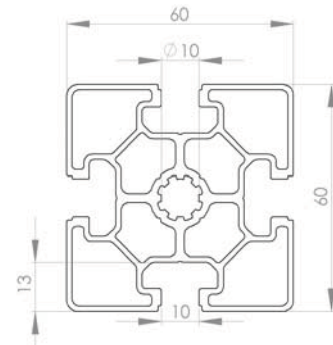

**Profil 60X60**

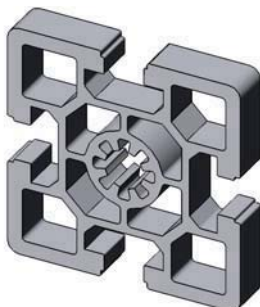

Artikel Nr.:	021432
Ix	52,00 cm <sup>4</sup>
Iy	52,00 cm <sup>4</sup>
Wx	17,30 cm <sup>3</sup>
Wy	17,30 cm <sup>3</sup>
Profilfläche	14,40 cm <sup>2</sup>
Masse	3,90 kg/m

**Nut 10**

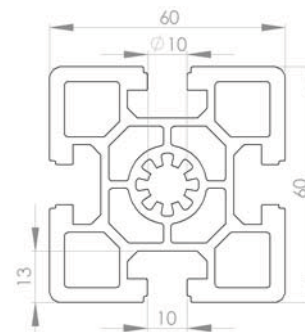

**Profil 60X90**



Artikel Nr.:	022264
Ix	212,40 cm <sup>4</sup>
Iy	88,50 cm <sup>4</sup>
Wx	47,20 cm <sup>3</sup>
Wy	29,50 cm <sup>3</sup>
Profilfläche	25,30 cm <sup>2</sup>
Masse	6,80 kg/m

**Nut 10**

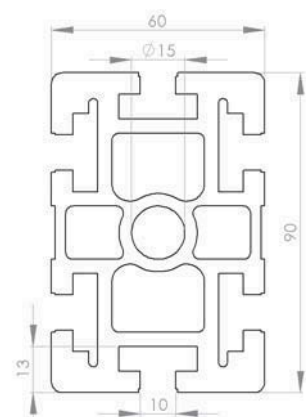

### Profil 80X80L

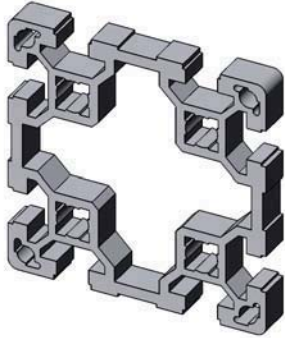

Artikel Nr.:	019615
Ix	132,10 cm <sup>4</sup>
Iy	132,10 cm <sup>4</sup>
Wx	33,00 cm <sup>3</sup>
Wy	33,00 cm <sup>3</sup>
Profilfläche	18,20 cm <sup>2</sup>
Masse	4,90 kg/m

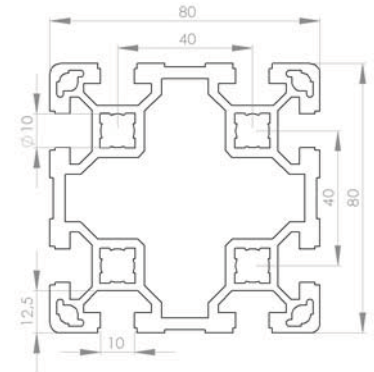

### Nut 10

### Profil 90X90L

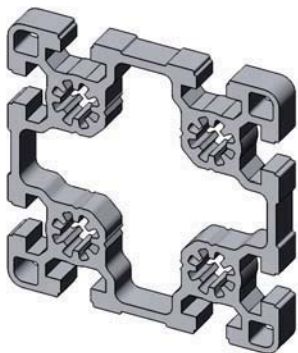

Artikel Nr.:	019616
Ix	210,00 cm <sup>4</sup>
Iy	210,00 cm <sup>4</sup>
Wx	46,40 cm <sup>3</sup>
Wy	46,40 cm <sup>3</sup>
Profilfläche	23,60 cm <sup>2</sup>
Masse	6,30 kg/m

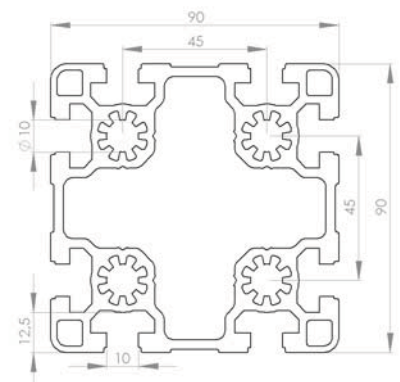

### Nut 10

### Profil 90X90

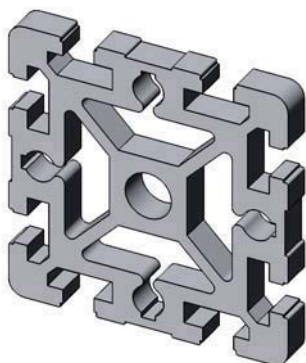

Artikel Nr.:	020994
Ix	299,80 cm <sup>4</sup>
Iy	299,80 cm <sup>4</sup>
Wx	67,00 cm <sup>3</sup>
Wy	67,00 cm <sup>3</sup>
Profilfläche	39,50 cm <sup>2</sup>
Masse	10,50 kg/m

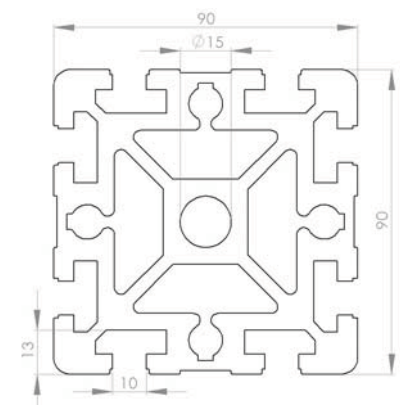

### Nut 10

**Profil 30X30 WG 40**

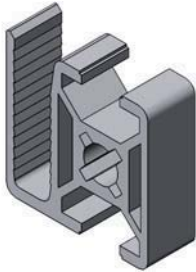

Artikel Nr.:	020994
Ix	2,40 cm <sup>4</sup>
Iy	2,90 cm <sup>4</sup>
Wx	1,50 cm <sup>3</sup>
Wy	1,80 cm <sup>3</sup>
Profilfläche	3,20 cm <sup>2</sup>
Masse	0,90 kg/m

**Nut 8**

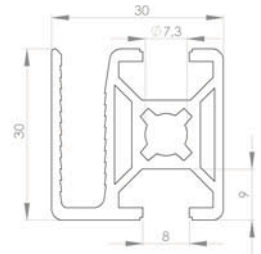

**Profil 30X40 WG 40**

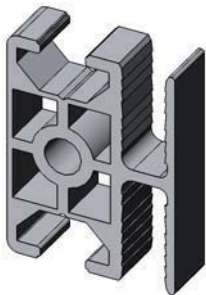

Artikel Nr.:	022863
Ix	6,90 cm <sup>4</sup>
Iy	4,10 cm <sup>4</sup>
Wx	4,30 cm <sup>3</sup>
Wy	1,80 cm <sup>3</sup>
Profilfläche	4,50 cm <sup>2</sup>
Masse	1,20 kg/m

**Nut 8**

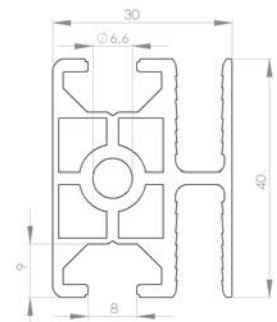

**Profil 22,5X45**

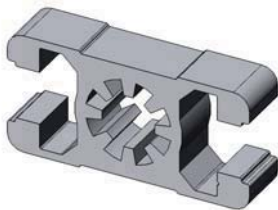

Artikel Nr.:	022330
Ix	7,10 cm <sup>4</sup>
Iy	2,90 cm <sup>4</sup>
Wx	3,60 cm <sup>3</sup>
Wy	2,60 cm <sup>3</sup>
Profilfläche	4,60 cm <sup>2</sup>
Masse	1,30 kg/m

**Nut 10**

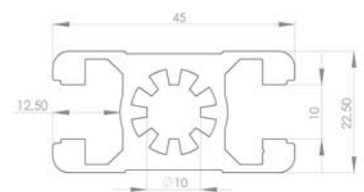

**Profil Teleskop 54X86**

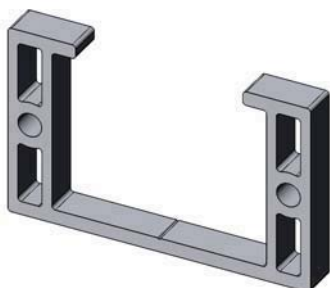

Artikel Nr.:	13004
Ix	cm <sup>4</sup>
Iy	cm <sup>4</sup>
Wx	cm <sup>3</sup>
Wy	cm <sup>3</sup>
Profilfläche	cm <sup>2</sup>
Masse	kg/m

**Nut 10**

